

jura®

en



ENA 8 INSTRUCTION FOR USE
Type 747



Your ENA 8

Control elements	36
Important information	38
Proper use	38
For your safety	38
1 Preparing and using for the first time	40
JURA on the Internet	40
Setting up the machine	40
Filling the bean container	40
Determining the water hardness	41
First-time use	41
Connecting milk	42
Connecting an accessory (via Bluetooth)	42
2 Preparation	43
Espresso, coffee and other speciality coffees	43
Latte macchiato, cappuccino and other speciality coffees with milk	43
Ground coffee	44
Adjusting the grinder	45
Hot water	45
3 Daily operation	45
Filling the water tank	45
Switching on the machine	46
Daily maintenance	46
Regular maintenance	46
Switching off the machine	46
4 Permanent settings in programming mode	47
Adjusting the product settings	48
Automatic switch-off	48
Energy-saving mode	49
Restore factory settings	49
Unit for amount of water	49
Setting the water hardness	49
Language	50
5 Maintenance	50
Rinsing the machine	50
Automatic milk system rinsing	51
Cleaning the milk system	51
Dismantling and rinsing the dual spout	52
Inserting/changing the filter	53
Cleaning the machine	54
Descaling the machine	54
Descaling the water tank	56
Cleaning the bean container	56



6	Display messages	57
7	Troubleshooting	58
8	Transport and environmentally friendly disposal	59
	Transport / Emptying the system	59
	Disposal	59
9	Technical data	59
10	Index	60
11	JURA contact details / Legal information	62

Symbol description

Warnings

 WARNING	Always take note of any information marked with the words CAUTION or WARNING and a warning sign. The signal word WARNING draws your attention to potential serious injury, and the signal word CAUTION to potential minor injury.
 CAUTION	
CAUTION	CAUTION draws your attention to potential damage to the machine.

Symbols used

- | | |
|---|---|
|  | Prompt to take action. This symbol means that you are being prompted to perform some action. |
|  | Information and tips to make it even easier to use your ENA. |
|  | Display |

Control elements

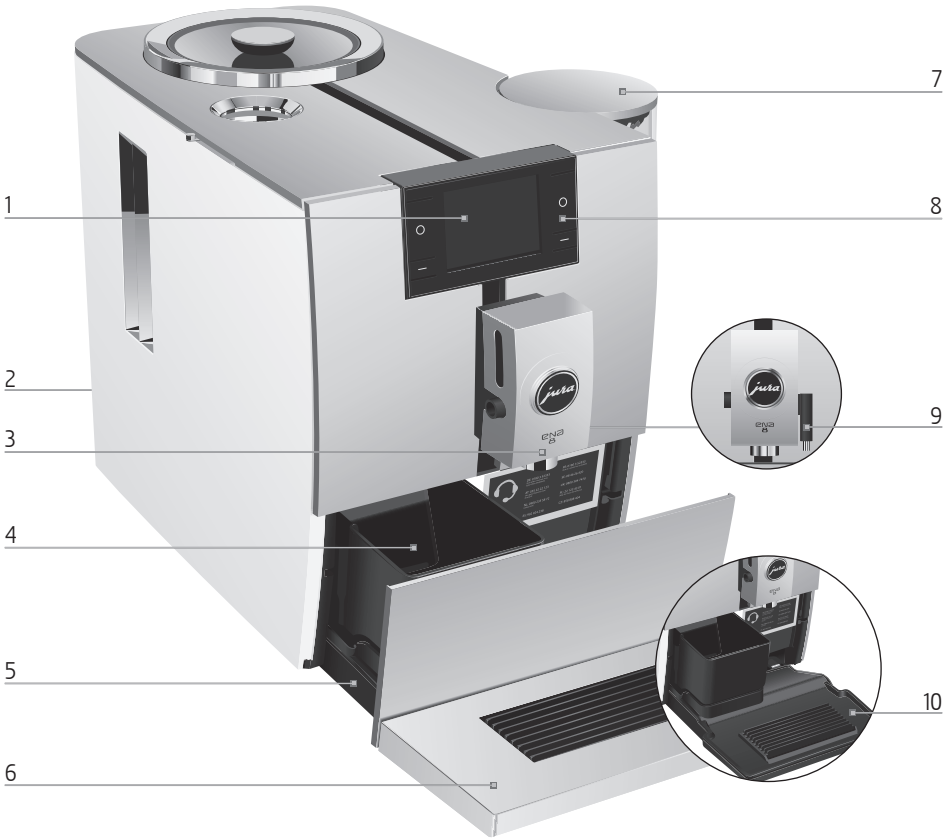

- 1 Display
- 2 Mains cable (back of the machine)
- 3 Height-adjustable dual spout
- 4 Coffee grounds container
- 5 Drip tray
- 6 Cup grille

- 7 Water tank (with cover)
- 8 Multi-function buttons (button function depends on what is shown in the display)
- 9 Hot-water spout
- 10 Insert for drip tray

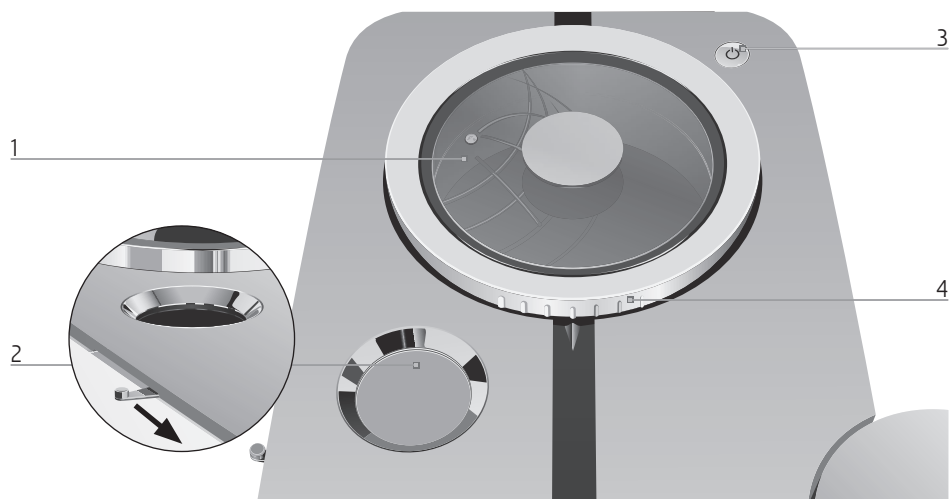

- | | | | |
|---|--|---|---|
| 1 | Bean container with aroma preservation cover | 3 | On/Off button  |
| 2 | Powder chute for ground coffee | 4 | Grinding wheel |



Back of the machine: Service socket for JURA Smart Connect (behind cover). Smart Connect is not included with all models.

Accessories

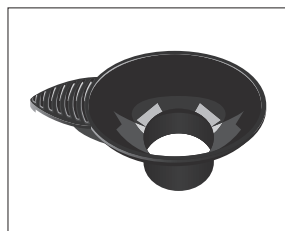

Filler funnel for ground coffee

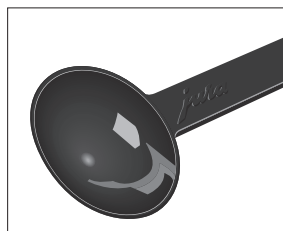

Measuring spoon for ground coffee



Container for milk system cleaning

Important information

Proper use

The machine is designed and intended for private domestic use. It should only be used for coffee preparation and to heat milk and water. Use for any other purpose will be deemed improper. JURA Elektroapparate AG cannot accept any responsibility for the consequences of improper use.

Before using the machine read these instructions for use thoroughly and completely and comply with the instructions they contain. A warranty service is not applicable for damage or defects caused by non-compliance with the instructions for use. Keep these instructions for use close to the machine and pass them on to the next user.

For your safety

Please carefully read and observe the important safety information set out below.

To avoid danger of potentially fatal electric shock:

- Never use a machine which is damaged or has a defective mains cable.
- In the event of signs of damage, for example if there is a smell of burning, unplug the machine immediately from the mains supply and contact JURA service.
- If the mains cable of this machine is damaged, it must be repaired either directly by JURA or by an authorised JURA service centre.
- Make sure that the ENA and the mains cable are not located close to hot surfaces.
- Be careful to ensure that the mains cable is not trapped and does not rub against sharp edges.
- Never open and repair the machine yourself. Do not modify the machine in any way that is not described in these instructions for use. The machine contains live parts. If opened, there is a danger of potentially fatal injury. Repairs may only be carried out by authorised JURA service centres, using original spare parts and accessories.
- To completely and safely disconnect the machine from the power supply, first switch off the ENA using the On/Off button . Only then should you remove the mains plug from the power socket.

There is a risk of scalds or burns on the spouts.

- Place the machine out of the reach of children.
- Do not touch any hot parts. Use the handles provided.
- Be careful to ensure that the dual spout is correctly installed and clean. If it is incorrectly fitted or becomes blocked, its parts might come off. There is a danger of parts being swallowed.

A defective machine is not safe and could cause injury or fire. To avoid damage and any associated risk of injury or fire:

- Never allow the mains cable to loosely hang down. The mains cable could pose a tripping hazard or become damaged.
- Protect the ENA from environmental influences such as rain, frost and direct sunlight.
- Do not immerse the ENA, mains cable or connections in water.
- Do not put the ENA or any individual parts in the dishwasher.
- Do not use alkaline cleaning agents; only use a soft cloth and mild cleaning agents.
- Switch your ENA off at the power switch before any cleaning operation. Always wipe the ENA

with a damp cloth rather than a wet one, and protect it from prolonged exposure to water splash.

- Only connect the machine to the mains voltage in accordance with the information on the rating plate. The rating plate is located on the underside of your ENA. Further technical data is provided in these instructions for use (see Chapter 9 'Technical data').
- Please only use original JURA maintenance products. Use of products that are not explicitly recommended by JURA could damage the machine.
- Do not use any coffee beans treated with additives or caramelised coffee beans.
- Only fill the water tank with fresh, cold water.
- Switch the machine off with the On/Off button  if you are going to be absent for a longer period of time and remove the mains plug from the power socket.
- Children may not clean or service the machine unless supervised by a responsible person.
- Do not allow children to play with the machine.

1 Preparing and using for the first time

- Keep children under the age of 8 away from the machine, or supervise them constantly.
- Children aged 8 and over may only operate the machine without supervision if they have been instructed in how to use it safely. Children must be able to recognise and understand the potential dangers arising from incorrect use.

People, including children, who

- do not have the physical, sensory or mental capabilities to use the machine safely or
- are inexperienced or lack knowledge in how to use the machine safely

must be supervised by a responsible person when using it, or must be instructed in how to use it correctly.

Safety when handling the CLARIS Smart / Smart mini filter cartridge:

- Filter cartridges should be kept out of the reach of children.
- Store filter cartridges in a dry place in the sealed packaging.
- Protect cartridges from heat and direct sunlight.
- Do not use damaged filter cartridges.
- Do not open filter cartridges.

1 Preparing and using for the first time

JURA on the Internet

Visit us on the Internet.

On the JURA website (www.jura.com) you will find interesting and up-to-date information on your ENA and on every aspect of coffee.

Setting up the machine

When setting up your ENA, please note the following:

- Place the ENA on a horizontal surface that is not sensitive to water.
- Choose a spot for your ENA which protects the machine against overheating. Ensure that the ventilation slots are not covered.

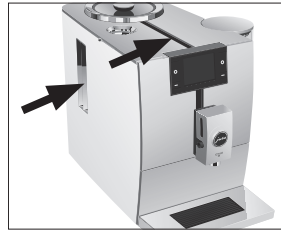

Filling the bean container

The bean container has an aroma preservation cover. This will ensure that your coffee beans retain their aroma for longer.

CAUTION

Coffee beans which have been treated with additives (e.g. sugar), ground coffee or freeze-dried coffee will damage the grinder.

- ▶ Only use roasted, untreated coffee beans to fill the bean container.
- ▶ Remove the aroma preservation cover.
- ▶ Remove any dirt or foreign objects from inside the bean container.
- ▶ Fill the bean container with coffee beans and close the aroma preservation cover.

Determining the water hardness

When you use the machine for the first time, you must set the water hardness. If you do not know the hardness of your water, you can find this out first. Use the Aquadur® test strips supplied with the machine.

- ▶ Hold the test strip briefly (for 1 second) under flowing water. Shake off the water.
- ▶ Wait for about 1 minute.
- ▶ You will then be able to read the degree of water hardness from the discolouration of the Aquadur® test strip and the description on the packaging.

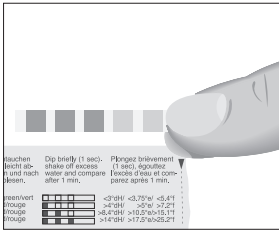

First-time use

⚠ WARNING

If the machine is operated with a defective mains cable, there is a danger of potentially fatal electric shock.

- ▶ Never use a machine which is damaged or has a defective mains cable.

CAUTION

Milk, sparkling mineral water or other liquids can damage the water tank or the machine.

- ▶ Only fill the water tank with fresh, cold water.

Precondition: The bean container has been filled.

- ▶ Insert the mains plug into a power socket.
- ▶ Press the On/Off button  to switch the ENA on.

'Choose language'

i To display more languages, press the '▶' button.

- ▶ Press the button that corresponds to the language you want, e.g. 'English'. 'Saved' appears briefly on the display to confirm the setting. 'Water hardness'

i If you do not know the hardness of your water, you must find this out first (see Chapter 1 'Preparing and using for the first time – Determining the water hardness').

- ▶ Press the '<' or '>' button to change the setting for the water hardness.
- ▶ Press the 'Save' button. 'Saved' appears briefly on the display. 'Filter operation' / 'Insert filter'
- ▶ Place a receptacle under the dual spout and the hot-water spout.



- ▶ Remove the water tank and rinse it with cold water.
- ▶ Fit the filter cartridge extension supplied on top of the CLARIS Smart mini filter cartridge.

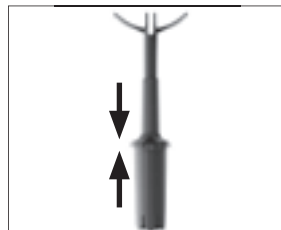

1 Preparing and using for the first time

- ▶ Insert the filter cartridge with its extension into the water tank.

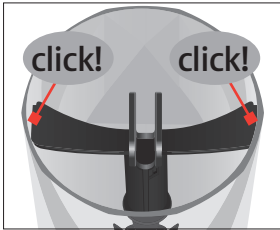

- ▶ Fill the water tank with fresh, cold water and reinsert the tank.

- i** The machine automatically detects that you have just inserted the filter cartridge.

'Saved'

'Filter is being rinsed', the filter is rinsed. Water flows directly into the drip tray.

- i** If the 'Empty drip tray' message appears, empty the drip tray and put it back into the machine.

'System is filling'

'Machine is heating'

'Machine is rinsing'

The rinse stops automatically. The start screen is displayed. Your ENA is ready for use.

- i** If the filter is active, this is indicated by a blue filter symbol at the bottom of the display.

Connecting milk

Your ENA creates fine, creamy, feather-light milk foam with a perfect consistency. The most important requirement for frothing milk is a milk temperature of 4–8 °C. We would therefore recommend using a milk cooler or a milk container.

- ▶ Remove the protective cover from the dual spout.

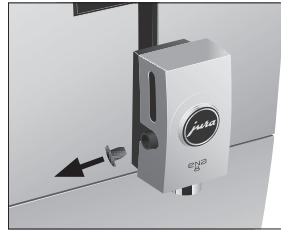

- ▶ Connect the milk pipe to the dual spout.

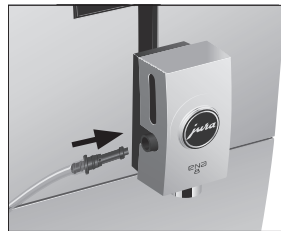

- ▶ Connect the other end of the milk pipe to a milk container or a milk cooler.

Connecting an accessory (via Bluetooth)

You have the option of connecting your ENA wirelessly to a compatible accessory (e.g. the Cool Control Wireless milk cooler). To do this, the receiver of the Cool Control or the JURA Smart Connect must be plugged into the service socket.

- i** The Smart Connect can be protected against unauthorised access using a PIN. Activate the PIN function via the JURA app. You will find more information at www.jura.com/smartconnect.
- i** Please note that you can only connect either the Cool Control or only one JURA app to the coffee machine via Smart Connect.

Precondition: The start screen is displayed.

- ▶ Press the 'P' button for **approximately 2 seconds** to enter programming mode.
- ▶ Press the '▶' button.

- ▶ Press the **'Machine settings'** button.
- ▶ Press the **'▶'** button several times until page **'4/5'** is displayed.
- ▶ Press the **'Connect accessory'** button.
- ▶ Now follow the instructions on the display to connect the accessory to the ENA.

2 Preparation

Basic information about preparing drinks:

- During the grinding operation you can change the **coffee strength** by pressing the **'<'** and **'>'** buttons.
- During preparation you can change the preset **amounts** (e.g. water and amount of milk foam) by pressing the **'<'** and **'>'** buttons.
- If you have selected settings during preparation, you can save these changes after preparation. To do this, press the **'Save'** button.
- You can stop preparation at any time. To do this, press the **'Cancel'** button.

Coffee tastes best served hot. A cold porcelain cup cools the beverage – and impairs the taste. We therefore recommend prewarming the cups. The full coffee aroma can develop only in prewarmed cups. You can purchase a JURA cup warmer from your specialised dealer.

You can make **permanent settings** for all products in programming mode (see Chapter 4 'Permanent settings in programming mode – Adjusting the product settings').

Espresso, coffee and other speciality coffees

Ristretto, espresso and coffee are all prepared following this model.

Two brewing operations are carried out for the espresso doppio to create a particularly full-bodied and aromatic speciality coffee.

Example: Proceed as follows to prepare one coffee.

Precondition: The start screen is displayed.

- ▶ Place a cup under the dual spout.



- ▶ Press the **'Coffee'** button. Preparation starts. **'Coffee'** and the coffee strength are displayed. The preset amount of water for coffee flows into the cup. Preparation stops automatically. Your ENA is once more ready for use.

Latte macchiato, cappuccino and other speciality coffees with milk

Your ENA prepares latte macchiato, cappuccino and other speciality coffees with milk at the touch of a button. There is no need to move the glass or cup.

Example: Proceed as follows to prepare one latte macchiato.

Precondition: The start screen is displayed. Milk is connected to the dual spout.

- ▶ Place a glass under the dual spout.



- ▶ Press the **'◀'** or **'▶'** button the number of times needed to display page **'2/5'**.

2 Preparation

- ▶ Press the **'Latte macchiato'** button. **'Latte macchiato'**, the preset amount of milk foam flows into the glass.

i There is a short interval while the hot milk separates from the milk foam. This allows the typical layers of a latte macchiato to form.

Coffee preparation starts. The preset amount of water for espresso flows into the glass. Preparation stops automatically. Your ENA is once more ready for use.

i 15 minutes after preparation, the milk system is automatically rinsed (see Chapter 5 'Maintenance – Automatic milk system rinsing'). Therefore always place a receptacle under the dual spout after preparing milk.

To ensure that the milk system in the dual spout always works properly, you must clean it **daily** (see Chapter 5 'Maintenance – Cleaning the milk system').

Ground coffee

You can choose to use a second coffee variety, for example decaffeinated coffee, with the filter funnel for ground coffee.

Basic information about ground coffee:

- Never add more than one level measuring spoon of ground coffee.
- Use ground coffee which is not ground too finely. Very fine coffee can block up the system so that the coffee only comes out in drips.
- If you did not fill the machine with a sufficient amount of ground coffee, **'Not enough ground coffee'** is displayed and the ENA stops the operation.
- The desired speciality coffee must be prepared within approximately one minute after filling with the ground coffee. Otherwise the ENA stops the operation and is once more ready for use.

All speciality coffees with ground coffee are always prepared following the same model.

Example: Proceed as follows to prepare one espresso using ground coffee.

Precondition: The start screen is displayed.

- ▶ Place an espresso cup under the coffee spout.
- ▶ Open the powder chute for ground coffee.

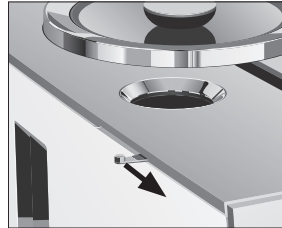

'Ground coffee' / 'Please add ground coffee'

- ▶ Fit the filler funnel for ground coffee.



- ▶ Place one level measuring spoon of ground coffee into the filler funnel.
- ▶ Remove the filler funnel and close the cover of the powder chute.
- ▶ Press the **'Espresso'** button. Preparation starts. **'Espresso'**, the preset amount of water for espresso flows into the cup. Preparation stops automatically. Your ENA is once more ready for use.

Adjusting the grinder

You can adjust the grinder to suit the degree of roast of your coffee.

CAUTION

If you adjust the consistency of grind when the grinder is not operating, the grinding wheel could be damaged.

- ▶ Only adjust the consistency of grind when the grinder is running.

The consistency of grind is correct if the coffee flows regularly from the coffee spout. In addition a fine, thick crema forms.

Grinding wheel (see image)

- 1: **Coarse** consistency of grind setting
- 2: **Fine** consistency of grind setting

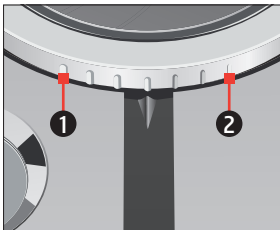

Example: Proceed as follows to change the consistency of grind **during** the preparation of an espresso.

- ▶ Place a cup under the dual spout.
- ▶ Press the **'Espresso'** button.
- ▶ Turn the grinder adjustment wheel to the desired position **while** the grinder is running.

The preset amount of water flows into the cup. Preparation stops automatically. Your ENA is once more ready for use.

Hot water

⚠ CAUTION

There is a danger of scalding from hot water splashes.

- ▶ Avoid direct contact with the skin.

Precondition: The start screen is displayed.

- ▶ Place a cup under the hot-water spout.



- ▶ Press the **'▶'** or **'◀'** button the number of times needed to display page **'5/5'**.
 - ▶ Press the **'Hot water'** button.
- 'Hot water'**, the preset amount of water flows into the cup.
- Preparation stops automatically. Your ENA is once more ready for use.

3 Daily operation

Filling the water tank

Daily maintenance of the machine and hygiene when handling milk, coffee and water are key to a perfect coffee result in the cup every time. You should therefore change the water **daily**.

CAUTION

Milk, sparkling mineral water or other liquids can damage the water tank or the machine.

- ▶ Only fill the water tank with fresh, cold water.
- ▶ Remove the water tank and rinse it with cold water.
- ▶ Fill the water tank with fresh, cold water and reinsert the tank.

Switching on the machine

- ▶ Place a receptacle under the dual spout.



- ▶ Press the On/Off button  to switch the ENA on.

'Welcome to JURA'
'Machine is heating'
'Machine is rinsing'

The rinse stops automatically. Your ENA is ready for use.

Daily maintenance

To ensure that you get many years of reliable service out of your ENA and to guarantee the optimum coffee quality, the machine requires daily maintenance.

- ▶ Pull out the drip tray.



- ▶ Empty the coffee grounds container and the drip tray. Rinse them both with warm water.

i Always empty the coffee grounds container when the machine is **switched on**. This is the only way of resetting the coffee grounds counter.

- ▶ Refit the coffee grounds container and the drip tray.
- ▶ Rinse the water tank with clean water.

- ▶ Clean the milk system in the dual spout (see Chapter 5 'Maintenance – Cleaning the milk system').
- ▶ Remove the milk pipe and rinse it thoroughly under running water.
- ▶ Dismantle and rinse the dual spout (see Chapter 5 'Maintenance – Dismantling and rinsing the dual spout').
- ▶ Wipe the surface of the machine with a clean, soft, damp cloth (e.g. microfibre cloth).

Regular maintenance

Carry out the following maintenance actions **regularly or as required**:

- In the interests of hygiene, we recommend changing the milk pipe and interchangeable milk spout on a regular basis (approximately every 3 months). Replacements are available from specialised dealers. Your ENA is equipped with the **HPI** milk system.
- Clean the inside of the water tank, e.g. with a brush. Further information about the water tank is provided in these instructions for use (see Chapter 5 'Maintenance – Descaling the water tank').
- Traces of milk and coffee may stick to the top and bottom of the cup grille. If this happens, clean the cup grille.

Switching off the machine

When the ENA is switched off, the system is automatically rinsed if a speciality coffee has been prepared. If milk has been prepared, you will also be prompted to clean the milk system.

- ▶ Place a receptacle under the dual spout.



- ▶ Press the On/Off button .

i If milk has been prepared, you will be prompted to clean the milk system ('Do you want to clean the milk system now?'). After 10 seconds the switch-off process continues automatically.

'Machine is rinsing', the system rinses itself. The operation stops automatically. Your ENA is switched off.

4 Permanent settings in programming mode

Press the 'P' button for approximately 2 seconds to enter programming mode. You can easily navigate through the programme items and permanently save the required settings using the multi-function buttons. The following settings can be made:

Programme item	Sub-item	Explanation
'Maintenance status'	'Clean', 'Clean the milk system', 'Descale', 'Filter' (only if filter is fitted), 'Rinse', 'Maintenance information'	▶ Here you can start the required maintenance programme or find out what maintenance actions are required.
'Product settings'		▶ Select your settings for speciality coffees and hot water.
'Machine settings'	'Switch off after'	▶ Set the time after which the ENA should switch off automatically.
	'Save energy'	▶ Activate energy-saving mode.
	'Factory setting'	▶ Reset the machine to its factory setting.
	'Units'	▶ Select the unit for the amount of water.
	'Water hardness'	▶ You can set the water hardness of the water used.
	'Choose language'	▶ Select your language.
	'Connect accessory', 'Disconnect accessories' (Only displayed if the JURA Smart Connect is being used.)	▶ Connect the ENA wirelessly to a JURA accessory or disconnect the connection again.
'Version'	Software version	

Adjusting the product settings

Press the button of a product on the start screen for **about 2 seconds** to view the list of setting options. The following permanent settings can be made:

Product	Coffee strength	Amount	More settings
Ristretto, Espresso	10 levels	Coffee: 15 ml – 80 ml	Temperature (low, normal, high)
Coffee	10 levels	Coffee: 25 ml – 240 ml	Temperature (low, normal, high)
Cappuccino, Flat white	10 levels	Coffee: 25 ml – 240 ml Milk foam: 3 sec. – 120 sec.	Temperature (low, normal, high)
Latte macchiato	10 levels	Coffee: 25 ml – 240 ml Milk foam: 3 sec. – 120 sec. Interval: 0 sec. – 60 sec.	Temperature (low, normal, high)
Espresso macchiato	10 levels	Coffee: 15 ml – 80 ml Milk foam: 3 sec. – 120 sec.	Temperature (low, normal, high)
Espresso doppio (2 brewing operations)	10 levels	Coffee: 30 ml – 160 ml	Temperature (low, normal, high)
Portion of milk foam	–	Milk foam: 3 sec. – 120 sec.	–
Hot water	–	Water: 25 ml – 450 ml	Temperature (low, normal, high)

Permanent settings in programming mode always follow the same model.

Example: Proceed as follows to change the **coffee strength** for one coffee.

Precondition: The start screen is displayed.

- ▶ Press the **'Coffee'** button for **approximately 2 seconds** until the list of possible settings appears.
- ▶ Press the **'Coffee strength'** button.
- ▶ Press the **'<'** or **'>'** button to change the setting for the coffee strength.
- ▶ Press the **'Save'** button. **'Saved'** appears briefly on the display.
- ▶ Press the **'Back'** button to return to the start screen.

Automatic switch-off

By instructing your ENA to automatically switch itself off, you can cut down your energy consumption. If this function is activated, your ENA switches off automatically after the preset time following the last action on the machine.

You can set the automatic switch-off to 15 minutes, 30 minutes or 1-9 hours.

Precondition: The start screen is displayed.

- ▶ Press the **'P'** button for **approximately 2 seconds** to enter programming mode.
- ▶ Press the **'▶'** button.
- ▶ Press the **'Machine settings'** button.
- ▶ Press the **'Switch off after'** button.
- ▶ Press the **'<'** or **'>'** button to change the setting.

- ▶ Press the 'Save' button.
'Saved' appears briefly on the display.
'Machine settings'
- ▶ Press the 'Back' button for **approximately 2 seconds** to return to the start screen.

Energy-saving mode

In the programme item 'Machine settings' / 'Save energy' you can set an energy-saving mode:

- 'Save energy' / 'Active'
 - Soon after the last preparation, the ENA stops heating up.
 - Before you can prepare a speciality coffee, speciality coffee with milk, or hot water, the machine must heat up.
- 'Save energy' / 'Inactive'
 - All speciality coffees, speciality coffees with milk and hot water can be prepared without having to wait.

Example: Proceed as follows to deactivate the energy-saving mode.

Precondition: The start screen is displayed.

- ▶ Press the 'P' button for **approximately 2 seconds** to enter programming mode.
- ▶ Press the '▶' button.
- ▶ Press the 'Machine settings' button.
- ▶ Press the 'Save energy' button.
'Save energy'
- ▶ Press the 'Inactive' button.
- ▶ Press the 'Save' button.
'Saved' appears briefly on the display.
'Machine settings'
- ▶ Press the 'Back' button for **approximately 2 seconds** to return to the start screen.

Restore factory settings

In the programme item 'Machine settings' / 'Factory setting' the machine can be reset to its factory setting.

Precondition: The start screen is displayed.

- ▶ Press the 'P' button for **approximately 2 seconds** to enter programming mode.

- ▶ Press the '▶' button.
- ▶ Press the 'Machine settings' button.
- ▶ Press the '▶' button.
'2/5'
- ▶ Press the 'Factory setting' button.
'Factory setting' / 'Reset the machine to the factory settings?'
- ▶ Press the 'Yes' button.
'Saved' appears briefly on the display.
Your ENA is switched off.

Unit for amount of water

In the programme item 'Machine settings' / 'Units' you can select the unit used for the amount of water.

Example: Proceed as follows to change the unit for the amount of water from 'ml' to 'oz'.

Precondition: The start screen is displayed.

- ▶ Press the 'P' button for **approximately 2 seconds** to enter programming mode.
- ▶ Press the '▶' button.
- ▶ Press the 'Machine settings' button.
- ▶ Press the '▶' button.
'2/5'
- ▶ Press the 'Units' button.
'Units'
- ▶ Press the 'oz' button.
- ▶ Press the 'Save' button.
'Saved' appears briefly on the display.
'Machine settings'
- ▶ Press the 'Back' button for **approximately 2 seconds** to return to the start screen.

Setting the water hardness

The harder the water is, the more frequently the ENA needs to be descaled. It is therefore important to set the water hardness accurately.

The water hardness was set when the machine was first used. You can change this setting at any time.

The water hardness can be adjusted on a continuous scale between 1 °dH and 30 °dH.

Precondition: The start screen is displayed.

- ▶ Press the 'P' button for **approximately 2 seconds** to enter programming mode.
- ▶ Press the '▶' button.
- ▶ Press the 'Machine settings' button.
- ▶ Press the '▶' button several times until page '3/5' is displayed.
- ▶ Press the 'Water hardness' button.
- ▶ Press the '<' or '>' button to change the setting.
- ▶ Press the 'Save' button.
- ▶ Press the 'Back' button for **approximately 2 seconds** to return to the start screen.

Language

In this programme item you can set the language used by your ENA.

Example: Proceed as follows to change the language from 'English' to 'Deutsch'.

Precondition: The start screen is displayed.

- ▶ Press the 'P' button for **approximately 2 seconds** to enter programming mode.
- ▶ Press the '▶' button.
- ▶ Press the 'Machine settings' button.
- ▶ Press the '▶' button several times until page '3/5' is displayed.
- ▶ Press the 'Choose language' button.
- ▶ Press the 'Deutsch' button.
- ▶ Press the 'Zurück' button for **approximately 2 seconds** to return to the start screen.

5 Maintenance

Your ENA has the following integrated maintenance programmes:

- Rinsing the machine ('Rinse')
 - Cleaning the milk system ('Clean the milk system')
 - Changing the filter (only if filter is fitted)
 - Cleaning the machine ('Clean')
 - Descaling the machine ('Descale')
- i** Clean the machine, descale the machine or change the filter when you are prompted to do so.
- i** In the programme item 'Maintenance status' you will find an overview of the maintenance programmes. When the bar is completely filled with red, your ENA will prompt you to perform the appropriate maintenance programme.
- i** In the interests of hygiene, you should clean the milk system **daily** when you have been preparing milk.

Rinsing the machine

You can initiate the rinse operation manually at any time.

Precondition: The start screen is displayed.

- ▶ Place a receptacle under the dual spout.



- ▶ Press the 'P' button for **approximately 2 seconds** to enter programming mode.
- ▶ Press the 'Maintenance status' button.
- ▶ Press the '▶' button several times until page '3/3' is displayed.

- ▶ Press the **'Rinse'** button.
'Machine is rinsing', **'Milk system is being rinsed'**, water flows out of the dual spout. The rinse stops automatically. Your ENA is once more ready for use.

Automatic milk system rinsing

15 minutes after milk preparation, the milk system is **automatically** rinsed. Therefore always place a receptacle under the dual spout after preparing milk.

Cleaning the milk system

To ensure that the milk system in the dual spout always works properly, you must clean it **daily** when you have been preparing milk.

CAUTION

If the wrong cleaning agent is used, the machine could be damaged and/or traces could be left behind in the water.

- ▶ Use only original JURA maintenance products.

- i** JURA milk system cleaner is available from specialised dealers.
- i** To clean the milk system, use the container supplied.

Precondition: The **'Cleaning the milk system'** (☞) symbol is displayed.

- ▶ Press the **'P'** button for **approximately 2 seconds** to enter programming mode.
- ▶ Press the **'Maintenance status'** button.
- ▶ Press the **'Clean the milk system'** button.
'Clean the milk system'
- ▶ Press the **'Start'** button.
- ▶ Press the **'Next'** button.
'Milk system cleaner'
- ▶ Remove the milk pipe from the milk container or milk cooler.

- ▶ Add milk system cleaner to the front part of the container up to the **bottom mark** (indicated by ☞).

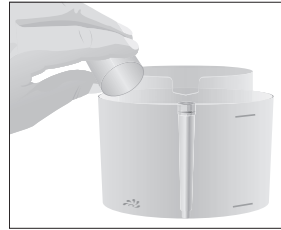

- ▶ Then fill with water up to the **upper mark**.
- ▶ Place the container under the dual spout.
- ▶ Connect the milk pipe to the container.

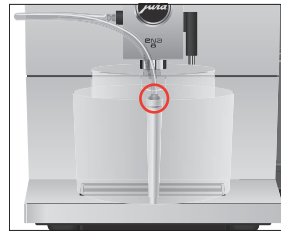

- i** To connect the milk pipe to the container correctly, the pipe must be fitted with a connector.

- ▶ Press the **'Next'** button.
'Milk system is being cleaned', the dual spout and the milk pipe are cleaned.
'Fresh water'
- ▶ Rinse the container thoroughly and fill the front part with fresh water up to the **upper mark**.
- ▶ Place it under the dual spout and reconnect the milk pipe with the container.
- ▶ Press the **'Next'** button.
'Milk system is being cleaned', the dual spout and the pipe are rinsed with fresh water.
The operation stops automatically. Your ENA is once more ready for use.

Dismantling and rinsing the dual spout

The dual spout must be dismantled and rinsed **daily** if milk has been prepared to make sure it functions perfectly and also in the interests of hygiene.

- ▶ Remove the milk pipe and rinse it thoroughly under running water.

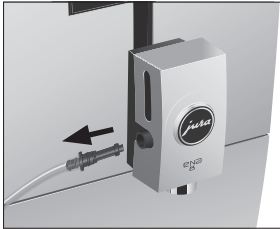

- ▶ Pull the cover of the dual spout forwards and off.



- ▶ Remove the milk system from the dual spout.

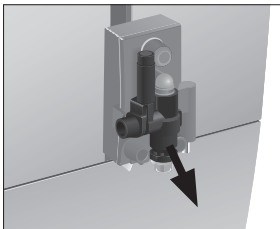

- ▶ Dismantle the milk system into its individual parts.

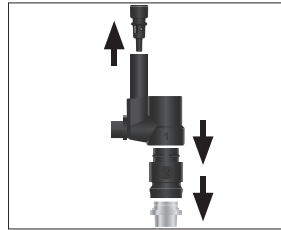

- ▶ Rinse all the parts under running water. If there are severely dried-on milk residues, firstly immerse the individual parts in a solution of 250 ml cold water and 1 capful of JURA milk system cleaner. Then rinse the parts thoroughly.
- ▶ Fit the air intake pipe.

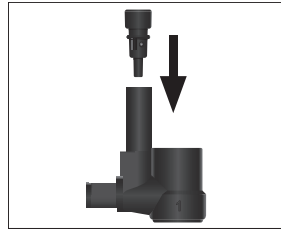

- ▶ Reassemble the milk system. When doing this, note the numbering of the individual parts.

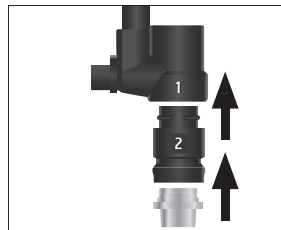

- ▶ Fit the assembled individual parts back in the dual spout and press it firmly.

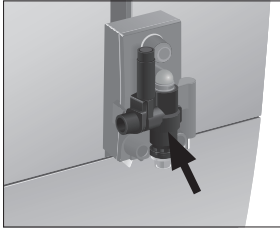

- ▶ Refit the cover of the dual spout.



Inserting/changing the filter

Your ENA no longer has to be descaled if you are using the CLARIS Smart / Smart mini filter cartridge.

- i** Once the filter cartridge stops working (depending on the water hardness setting), the ENA will prompt you to change the filter.
- i** CLARIS Smart / Smart mini filter cartridges are available from specialised dealers.

Precondition: The start screen is displayed. (If the filter needs to be changed, the  symbol is also displayed.)

- ▶ Remove and empty the water tank.

- ▶ Remove the used filter cartridge from the water tank.

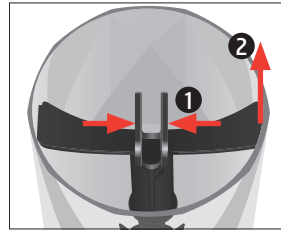

- ▶ Fit the filter cartridge extension on top of a **new** CLARIS Smart / Smart minifilter cartridge.

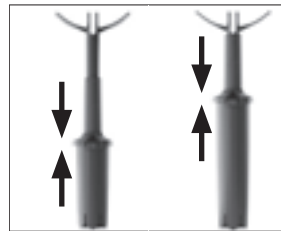

- ▶ Insert the filter cartridge with its extension into the water tank.

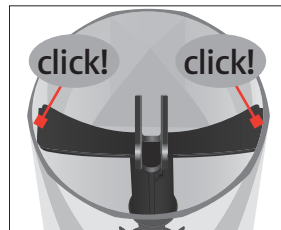

- ▶ Fill the water tank with fresh, cold water and reinsert the tank.

The machine has automatically detected that you have just inserted/changed the filter cartridge.

'Filter is being rinsed', the filter is rinsed.

Water flows directly into the drip tray.

The start screen is displayed. Your ENA is once more ready for use.

Cleaning the machine

After 160 preparations or 80 switch-on rinses, the ENA will prompt you to clean it.

CAUTION

If the wrong cleaning agent is used, the machine could be damaged and/or traces could be left behind in the water.

- ▶ Use only original JURA maintenance products.

- i** The cleaning programme lasts approximately 20 minutes.
- i** Do not interrupt the cleaning programme. The quality of cleaning will be impaired if you do so.
- i** JURA cleaning tablets are available from specialised dealers.

Precondition: The 'Cleaning the machine' (☞) symbol is displayed.

- ▶ Press the 'P' button for **approximately 2 seconds** to enter programming mode.
- ▶ Press the 'Maintenance status' button.
- ▶ Press the 'Clean' button.
'Clean'
- ▶ Press the 'Start' button.
- ▶ Press the 'Next' button.
'Empty coffee grounds container'
- ▶ Empty the drip tray and coffee grounds container and put them back into the machine.
'Clean'
- ▶ Place a receptacle under the dual spout.



- ▶ Press the 'Next' button.
'Machine is being cleaned', water flows out of the dual spout.
The operation is interrupted, 'Add cleaning tablet'.
- ▶ Open the powder chute for ground coffee.
- ▶ Insert a JURA cleaning tablet into the powder chute.

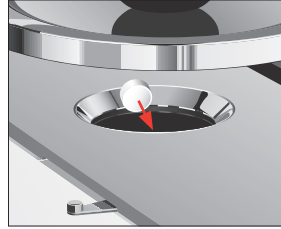

- ▶ Close the powder chute.
'Clean'
- ▶ Press the 'Next' button.
'Machine is being cleaned', water flows out of the dual spout repeatedly.
The operation stops automatically.
'Empty coffee grounds container'
- ▶ Empty the drip tray and coffee grounds container and put them back into the machine.
Your ENA is once more ready for use.

Descaling the machine

The ENA builds up deposits of limescale over time and automatically prompts you to descale it when necessary. The degree of calcification depends on the hardness of your water.

- i** If you are using a CLARIS Smart / Smart mini filter cartridge, you will not be prompted to descale.

⚠ CAUTION

If the descaling agent comes into contact with the skin or eyes, this can cause irritation.

- ▶ Avoid contact with the skin or eyes.
- ▶ Rinse off the descaling agent with clean water. Should you get any descaling agent in your eye, see a doctor.

CAUTION

If the wrong descaling agent is used, the machine could be damaged and/or traces could be left behind in the water.

- ▶ Use only original JURA maintenance products.

CAUTION

If the descaling operation is interrupted, there may be damage to the machine.

- ▶ Allow the descaling programme to run to the end.

CAUTION

If the descaling agent comes into contact with sensitive surfaces (e.g. marble), damage cannot be ruled out.

- ▶ Clean up any splashes immediately.

- i** The descaling programme lasts approximately 40 minutes.
- i** JURA descaling tablets are available from specialised dealers.

Precondition: The 'Descaling the machine' (☞) symbol is displayed.

- ▶ Press the '**P**' button for **approximately 2 seconds** to enter programming mode.
- ▶ Press the '**Maintenance status**' button.
- ▶ Press the '**▶**' button.
- ▶ Press the '**Descale**' button.
- ▶ Press the '**Start**' button.
- ▶ Press the '**Next**' button.

- ▶ Empty the drip tray and coffee grounds container and put them back into the machine.

'Agent in tank'

- ▶ Remove and empty the water tank.
- ▶ Completely dissolve 3 JURA descaling tablets in a receptacle holding 500 ml of water. This may take several minutes.

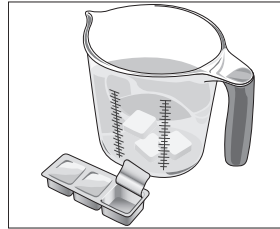

- ▶ Pour the solution into the **empty** water tank and insert it into the machine.
- ▶ Place a receptacle under the hot-water spout.



- ▶ Press the '**Next**' button.
- ▶ **'Machine is being descaled'**, water flows repeatedly out of the dual spout and the hot-water spout. The operation is interrupted, **'Empty drip tray'**.
- ▶ Empty the drip tray and coffee grounds container and put them back into the machine.
- ▶ **'Rinse the water tank' / 'Fill water tank'**
- ▶ Empty the receptacle and place it under the hot-water and dual spouts.
- ▶ Remove the water tank and rinse it thoroughly.

5 Maintenance

- ▶ Fill the water tank with fresh, cold water and reinsert the tank.
- ▶ Press the 'Next' button.
'Machine is being descaled', the descaling operation is continued, water flows out of the dual spout and the hot-water spout.
'Empty drip tray'
- ▶ Empty the drip tray and coffee grounds container and put them back into the machine.
Your ENA is once more ready for use.

i If the descaling operation stops unexpectedly, rinse the water tank thoroughly.

Descaling the water tank

Limescale deposits may form in the water tank. To ensure correct function of the machine, descale the water tank from time to time.

- ▶ Remove the water tank.
- ▶ If you use a CLARIS Smart / Smart mini filter cartridge, remove this.
- ▶ Completely fill the water tank and dissolve 3 JURA descaling tablets in it.
- ▶ Leave the water tank with the descaling solution for several hours (e.g. overnight).
- ▶ Empty the water tank and rinse it thoroughly.
- ▶ If you use a CLARIS Smart / Smart mini filter cartridge, insert this again.
- ▶ Fill the water tank with fresh, cold water and reinsert the tank.

Cleaning the bean container

Coffee beans may be covered with a slight oil film which remains on the walls of the bean container. These traces may negatively affect the coffee result. For this reason clean the bean container from time to time.

Precondition: 'Fill bean container' is displayed.

- ▶ Switch the machine off with the On/Off button .
- ▶ Remove the aroma preservation cover.
- ▶ Clean the bean container with a soft, dry cloth.
- ▶ Fill the bean container with coffee beans and close the aroma preservation cover.

6 Display messages

Message	Cause/Result	Action
'Fill water tank'	The water tank is empty. You cannot prepare any products.	▶ Fill the water tank (see Chapter 3 'Daily operation – Filling the water tank').
'Empty coffee grounds container'	The coffee grounds container is full. You cannot prepare any products.	▶ Empty the coffee grounds container and the drip tray (see Chapter 3 'Daily operation – Daily maintenance').
'Drip tray not fitted'	The drip tray is not inserted correctly or is not inserted at all. You cannot prepare any products.	▶ Fit the drip tray.
'Fill bean container'	The bean container is empty. You cannot prepare any speciality coffees, but you can prepare hot water and milk.	▶ Fill the bean container (see Chapter 1 'Preparing and using for the first time – Filling the bean container').
The 'Changing the filter' (☑) symbol is displayed in red.	The filter cartridge no longer works.	▶ Replace the CLARIS Smart / Smart mini filter cartridge (see Chapter 5 'Maintenance – Inserting/changing the filter').
The 'Cleaning the machine' (☑) symbol is displayed.	The ENA is prompting you to clean it.	▶ Perform cleaning (see Chapter 5 'Maintenance – Cleaning the machine').
The 'Descaling the machine' (☑) symbol is displayed.	The ENA is prompting you to descale it.	▶ Perform descaling (see Chapter 5 'Maintenance – Descaling the machine').
The 'Cleaning the milk system' (☑) symbol is displayed.	The ENA prompts you to clean the milk system.	▶ Perform milk system cleaning (see Chapter 5 'Maintenance – Cleaning the milk system').
'Too hot'	The system is too hot to start a maintenance programme.	▶ Wait for several minutes until the system has cooled or prepare a speciality coffee or hot water.

7 Troubleshooting

Problem	Cause/Result	Action
Insufficient foam is produced when the milk is frothed or milk sprays from the dual spout.	The dual spout is dirty.	<ul style="list-style-type: none"> ▶ Clean the milk system in the dual spout (see Chapter 5 'Maintenance – Cleaning the milk system'). ▶ Dismantle and rinse the dual spout (see Chapter 5 'Maintenance – Dismantling and rinsing the dual spout').
Coffee only comes out in drips when it is being prepared.	Coffee or ground coffee has been ground too finely and is blocking the system. The water hardness may not have been correctly set.	<ul style="list-style-type: none"> ▶ Put the grinder on a coarser setting or use coarser ground coffee (see Chapter 2 'Preparation – Adjusting the grinder'). ▶ Perform descaling (see Chapter 5 'Maintenance – Descaling the machine').
'Fill water tank' is not displayed although the water tank is empty.	There is a lot of limescale in the water tank.	▶ Descale the water tank (see Chapter 5 'Maintenance – Descaling the water tank').
Grinder is making a very loud noise.	There are foreign objects in the grinder.	▶ Contact customer support in your country (see Chapter 11 'JURA contact details / Legal information').
'Error 2' or 'Error 5' is displayed.	If the machine has been exposed to the cold for a long period of time, heating may be disabled for safety reasons.	▶ Warm the machine at room temperature.
Other 'Error' messages are displayed.	–	▶ Switch the ENA off with the On/Off button  . Contact customer support in your country (see Chapter 11 'JURA contact details / Legal information').

i If you were unable to solve the problem, contact customer support in your country (see Chapter 11 'JURA contact details / Legal information').

8 Transport and environmentally friendly disposal

Transport / Emptying the system

Keep the packaging for your ENA. It should be used to protect the machine during transport.

In order to protect the ENA from frost during transport, the system must be emptied.

Precondition: The start screen is displayed.

- ▶ Remove the milk pipe from the dual spout.
- ▶ Place a receptacle under the hot-water spout.



- ▶ Press the '▶' or '◀' button the number of times needed to display page '5/5'.
- ▶ Press the 'Hot water' button.
'Hot water', hot water flows out of the hot-water spout.
- ▶ Remove and empty the water tank.
Water will flow out of the hot-water spout until the system is empty.
'Fill water tank'
- ▶ Press the On/Off button .
Your ENA is switched off.

Disposal

Please dispose of old machines in an environmentally neutral way.



Old machines contain valuable, recyclable materials which should be recycled. Please therefore dispose of old machines via suitable collection systems.

9 Technical data

Voltage	220 – 240 V ~, 50 Hz
Power	1450 W
Conformity mark	CE
Pump pressure	static, max. 15 bar
Holding capacity of water tank (without filter)	1.1 l
Holding capacity of bean container	125 g
Holding capacity of coffee grounds container	approx. 10 servings
Cable length	approx. 1.2 m
Weight	Art. 15241: approx. 10.9 kg Art. 15252/15240/15254: approx. 9.4 kg
Dimensions (W × H × D)	27.1 × 32.3 × 44.5 cm
Milk system	HP1

10 Index

A

- Addresses 62
- Adjusting the product settings 48
- Aroma preservation cover
 - Bean container with aroma preservation cover 37
- Automatic switch-off 48

B

- Bean container
 - Bean container with aroma preservation cover 37
 - Cleaning 56
 - Filling 40
- Bluetooth 42
- Bus bar
 - Technical data 59
- Button
 - On/Off button 37

C

- Caffè latte 43
- Cappuccino 43
- Cappuccino frother cleaning
 - Cleaning the milk system 51
- CLARIS Smart mini filter cartridge
 - Changing 53
 - Inserting 53
- Cleaning
 - Bean container 56
 - Machine 54
- Coffee 43
- Coffee grounds container 36
- Connecting an accessory 42
- Consistency of grind
 - Adjusting the grinder 45
 - Grinding wheel 37, 45
- Contact details 62
- Cup grille 36
- Customer support 62

D

- Daily maintenance 46
- Descaling
 - Machine 54
 - Water tank 56
- Display 36
- Display messages 57

- Disposal 59
- Drip tray 36
 - Insert 36
- Dual spout
 - Dismantling and cleaning 52
 - Height-adjustable dual spout 36

E

- Emptying the system 59
- Energy-saving mode 49
- Errors
 - Troubleshooting 58
- Espresso 43
- Espresso doppio 43

F

- Factory settings
 - Restore factory settings 49
- Filler funnel
 - Filler funnel for ground coffee 37
- Filling
 - Bean container 40
 - Water tank 45
- Filter
 - Changing 53
 - Inserting 53
- First-time use 41
- Flat white 43

G

- Ground coffee 44
 - Measuring spoon for ground coffee 37
 - Powder chute for ground coffee 37

H

- Homepage 40
- Hotline 62
- Hot water 45
- Hot-water spout 36

I

- Insert for drip tray 36
- Instant coffee
 - Ground coffee 44
- Internet 40

J

- JURA
 - Contact details 62
 - Internet 40

L

- Language 50
- Latte macchiato 43

M

- Machine
 - Cleaning 54
 - Daily maintenance 46
 - Descaling 54
 - Regular maintenance 46
 - Rinsing 50
 - Setting up 40
 - Switching off 46
 - Switching on 46
- Mains cable 36
- Maintenance 50
 - Daily maintenance 46
 - Regular maintenance 46
- Measuring spoon for ground coffee 37
- Messages, display 57
- Milk
 - Connecting milk 42
- Milk system 59
 - Cleaning 51
- Milk system rinsing 51

P

- Permanent settings in programming mode 47
- Powder chute
 - Powder chute for ground coffee 37
- Preparation 43
 - Cappuccino 43
 - Coffee 43
 - Espresso 43
 - Espresso doppio 43
 - Espresso macchiato 43
 - Flat white 43
 - Ground coffee 44
 - Hot water 45
 - Latte macchiato 43
 - Ristretto 43
- Problems
 - Troubleshooting 58
- Product settings
 - Adjusting 48
- Programming mode 47
 - Automatic switch-off 48
 - Energy-saving mode 49

- Language 50
- Restore factory settings 49
- Setting the water hardness 49
- Unit for amount of water 49
- Proper use 38

R

- Regular maintenance 46
- Rinsing
 - Machine 50
- Ristretto 43

S

- Safety 38
- Safety information 38
- Service socket 37
- Settings
 - Permanent settings in programming mode 47
- Setting up
 - Setting up the machine 40
- Smart Connect 37
- Spout
 - Height-adjustable dual spout 36
 - Hot-water spout 36
- Switching off 46
- Switching on 46
- Switch-off
 - Automatic switch-off 48
- Symbol description 35

T

- Technical data 59
 - Milk system 59
- Tel 62
- Transport 59
- Troubleshooting 58

U

- Unit for amount of water 49
- Use, First-time 41

W

- Water hardness
 - Determining the water hardness 41
 - Setting the water hardness 49
- Water tank 36
 - Descaling 56
 - Filling 45
- Website 40

11 JURA contact details / Legal information

JURA Elektroapparate AG
Kaffeeweltstrasse 10
CH-4626 Niederbuchsiten
Tel. +41 (0)62 38 98 233

- @ You will find additional contact details for your country at www.jura.com.
- @ If you need assistance with using your machine, you can find this at www.jura.com/service.

Directives

The machine complies with the following directives:

- 2014/35/EU – Low Voltage Directive
- 2014/30/EU – Electromagnetic Compatibility
- 2009/125/EC – Ecodesign Directive
- 2011/65/EU – RoHS Directive

Technical changes

We reserve the right to make technical changes. The diagrams used in these instructions for use are for illustration purposes only and do not represent the original colours of the machine. Some details of your ENA may vary.

Feedback

Your opinion is important to us! Use the contact details at www.jura.com.

Copyright

The instructions for use contain information which is protected by copyright. It is not permitted to photocopy these instructions for use or translate them into another language without the prior written consent of JURA Elektroapparate AG.

